

18601PC

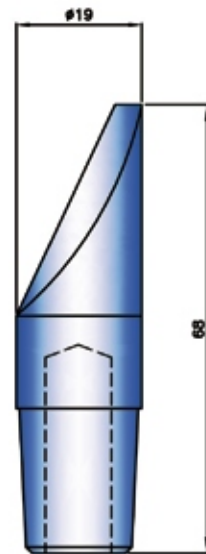

18601FL

ELETTRODI PER PUNTATRICI

CONO Ø 18 CON. 10%

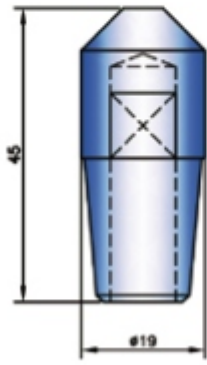

18602

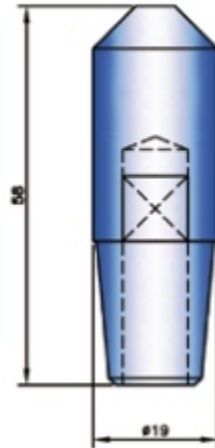

18603

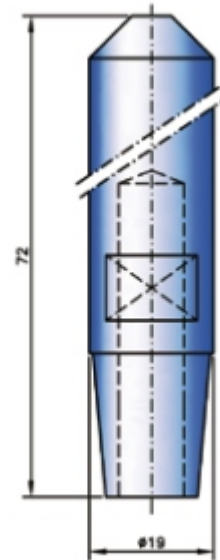

18604

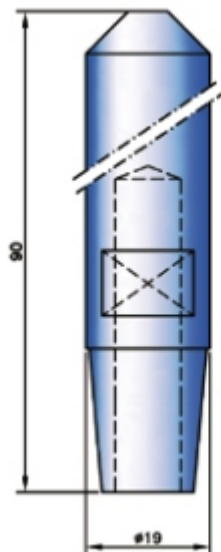

18605

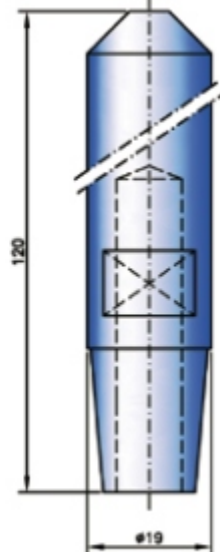

18606

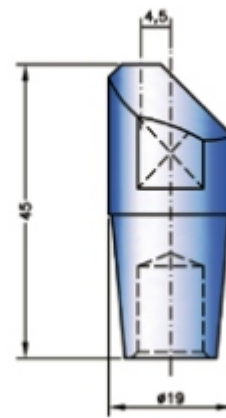

18607

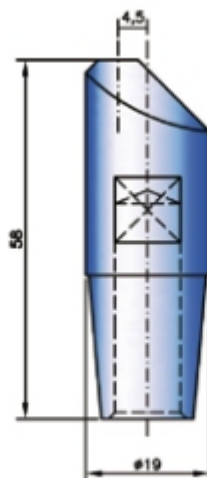

18608

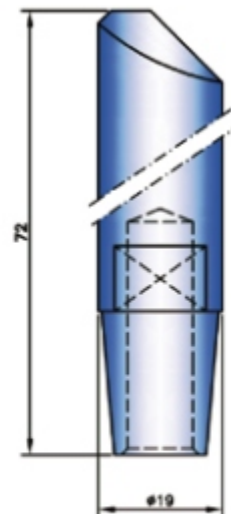

18609

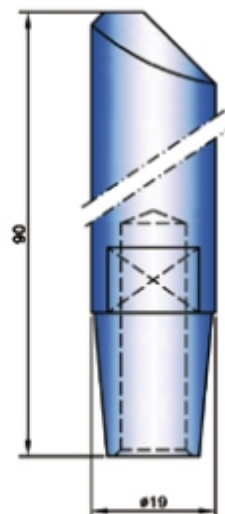

18610

TECSAL 2

PUNTATRICI ELETTRICHE E ACCESSORI ~ AUTOMAZIONI ~ RAME ELETTROLITICO E SUE LEGHE ~ ASSISTENZA E RIPARAZIONE

Via Luigi Galvani, 13 - 33083 VILLOTTA DI CHIONS (PN) - Tel. 0434 630661 - Fax 0434 630652 - info@tecsal2.it - www.tecsal2.it

ELETTRODI PER PUNTATRICI

CONO Ø 18 CON. 10%

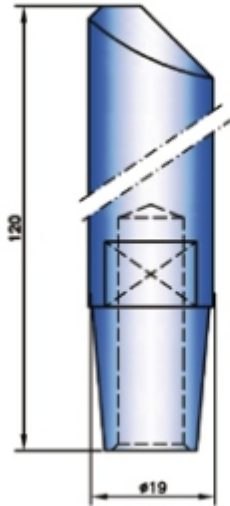

18611

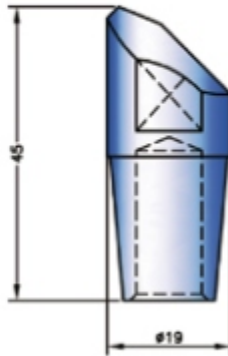

18612

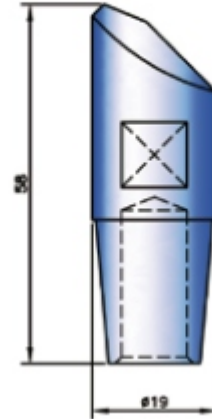

18613

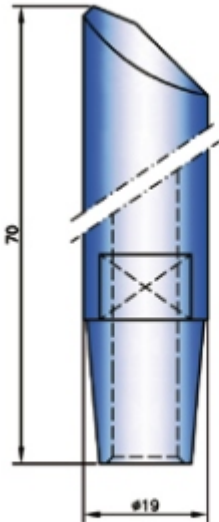

18614

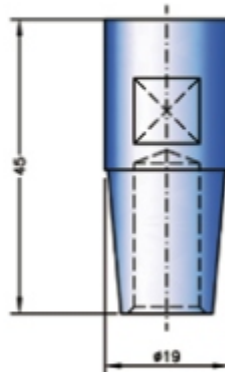

18615

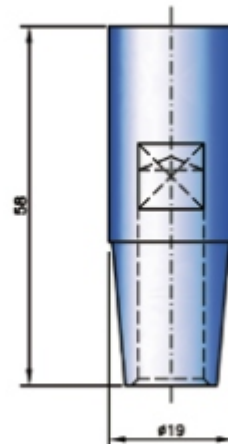

18616

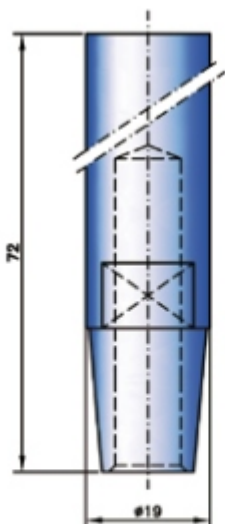

18617

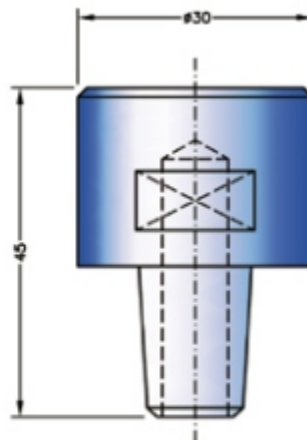

18618

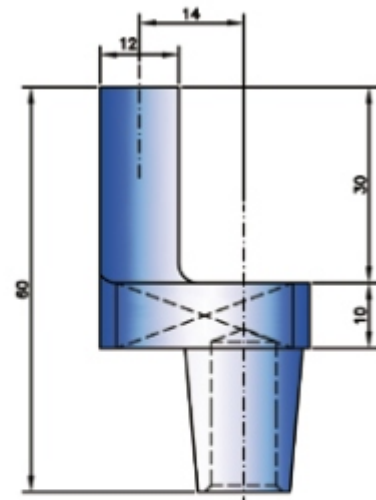

18619

TECSAL 2

PUNTATRICI ELETTRICHE E ACCESSORI ~ AUTOMAZIONI ~ RAME ELETTROLITICO E SUE LEGHE ~ ASSISTENZA E RIPARAZIONE

Via Luigi Galvani, 13 - 33083 VILLOTTA DI CHIONS (PN) - Tel. 0434 630661 - Fax 0434 630652 - info@tecsal2.it - www.tecsal2.it

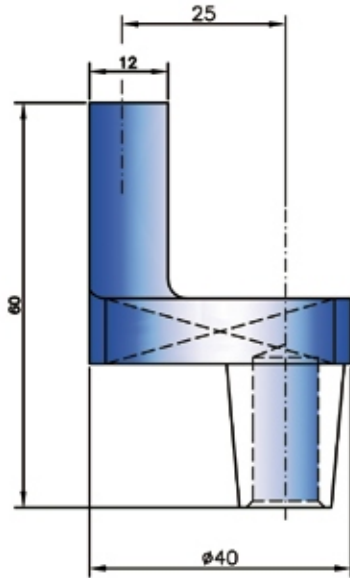

18620

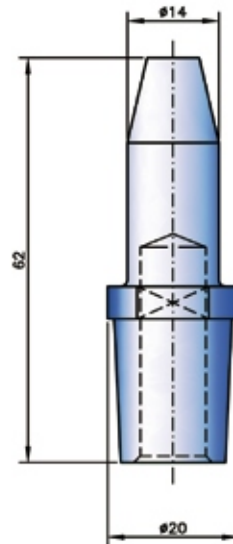

18621

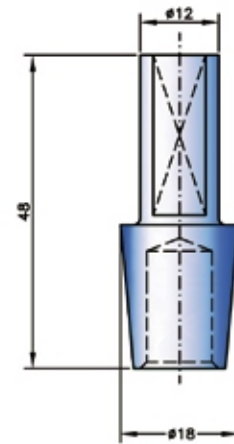

18622

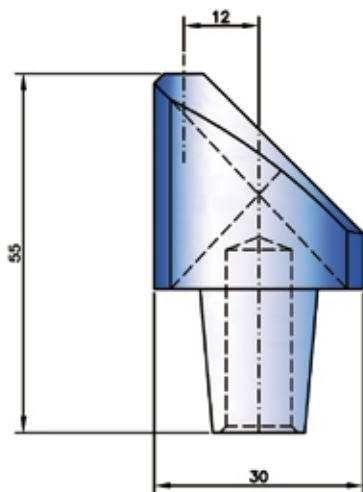

18623

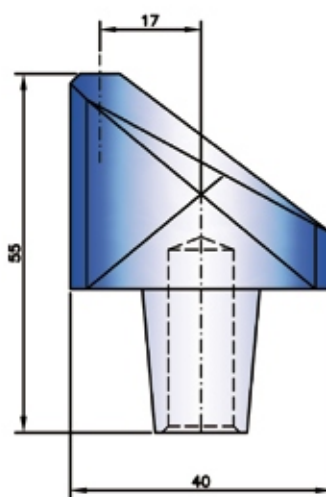

18624

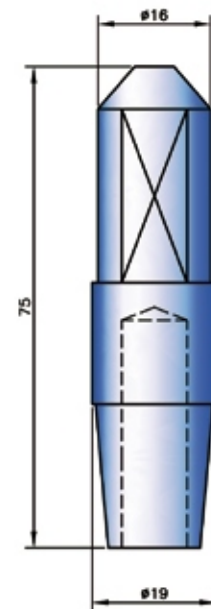

18625

ELETTRODI PER PUNTATRICI

CONO Ø 18 CON. 10%

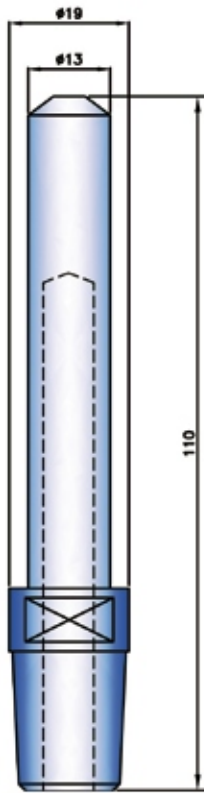

18626

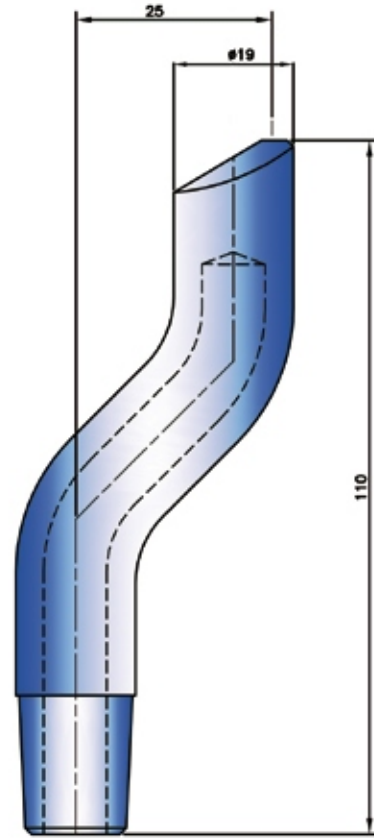

18627

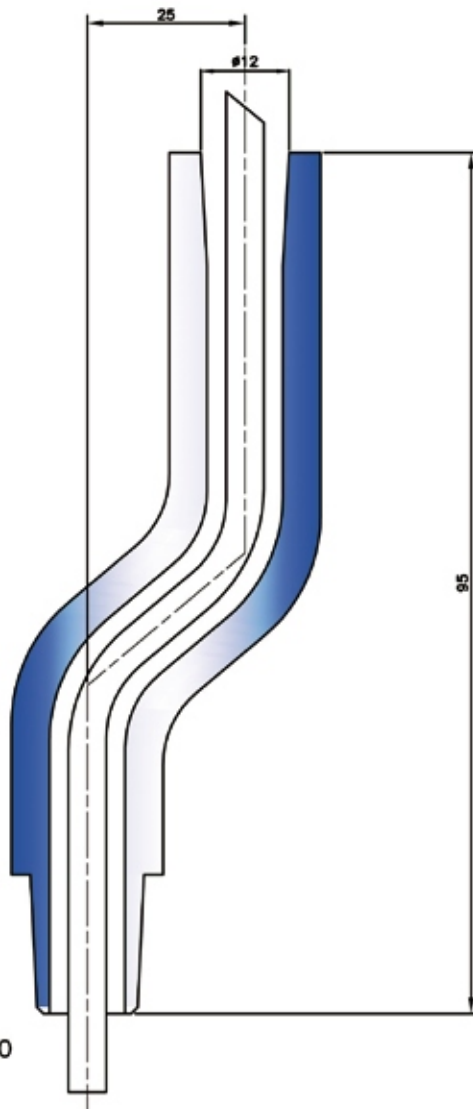

18630

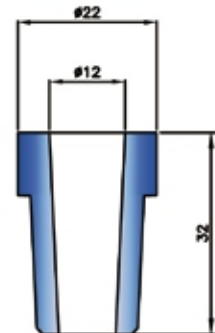

18622

TECSAL 2

PUNTATRICI ELETTRICHE E ACCESSORI ~ AUTOMAZIONI ~ RAME ELETTROLITICO E SUE LEGHE ~ ASSISTENZA E RIPARAZIONE

Via Luigi Galvani, 13 - 33083 VILLOTTA DI CHIONS (PN) - Tel. 0434 630661 - Fax 0434 630652 - info@tecsal2.it - www.tecsal2.it